

tamart[®]

Price List

Euro

May 2026 | ex VAT RRP | EUR

Central Stool

The three-legged Central Stool was originally designed by Tamar de Shalit in 1951 as a student at London's Central School of Arts and Crafts. The smooth, half-moon, turned wooden form features three tapered legs and crafted mortise and tenon joints. The piece works either as an occasional table or a stool; its straight side can align with the wall or if paired with another stool forms a fully circular side table, which is then secured with hidden magnet fixings.

The Central Stool is a versatile seat or side table. It can be purchased as a single unit (1 stool) or as a pair (2 stools). A pair of stools is more sustainable to produce, thus more economical to purchase; here the two top surfaces are CNC'd from boards of solid hardwood, that are a premium AA rating, with matching grains and colouration. The packaging for one piece or a pair of stools is the same size. Fixed imbedded felt feet pads are partially recessed into the leg and come as standard.

Dimensions	W46.5 × D27 × H43.5 cm (single) Ø46.5 × H43.5 cm (pair)	
Weight	2.1 kg (single) 4.2 kg (pair)	
Material	Solid FSC timber: Natural ash, black stained ash, natural oak	
Finish	Oiled	
CoO Origin	PL	
HS Code	9403601000	
Tests and Certifications	Tests: EN 16139:2013, BS EN 15372:2016 , BS EN 15372:2016 Certificates: FSC 100% and PEFC 100%	
Package dimensions	W49.5 × D36 × H48.5 cm	
Packaged weight	3 kg (single) 6 kg (pair)	
Availability	Lead time 8–10 weeks	
Price (single)	SKU	Excl. VAT
Black stained ash	TT-CS1-A-B	371 EUR
Natural ash	TT-CS1-A-N	439 EUR
Natural oak	TT-CS1-O-N	474 EUR
Price (pair)	SKU	Excl. VAT
Black stained ash	TT-CS2-A-B	661 EUR
Natural ash	TT-CS2-A-N	751 EUR
Natural oak	TT-CS2-O-N	836 EUR

Retail (RRP) excluding duties, VAT, shipping fees and import taxes

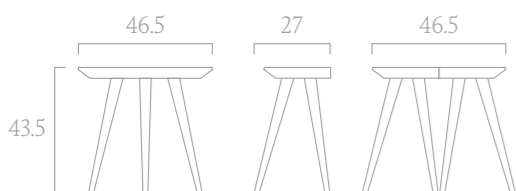

[View Central Stool](#)

Clore Floor Lamp

The Clore Floor Lamp, is Tamart's first lighting design and joins the Clore Collection originally designed by Tamar de Shalit for Sir Charles Clore's 1960s penthouse. Offering a diffusive illumination, the lamp features an elliptical handblown opaque glass shade, that sits within a solid wooden cradle. The traditionally crafted ovoid shade is made in Czechia by artisans layering opaque white and clear polished glass. The sturdy timber base is offered in Tamart's sustainably sourced and premium AA graded hardwoods: natural oak, ash and black stained ash, with a black braided cable and a foot dimmer.

With its commanding poised presence, the hybrid 'furniture-lamp' offers timeless elegance brought to life for a new generation; the light can be specified for a range of projects from residential and hospitality, to living spaces and breakout areas. Fixed imbedded felt feet pads are partially recessed into the legs and come as standard. This product is delivered in 2 boxes.

Dimensions	W41 × D41 × H83.2 cm Shade: H41 cm × Ø30.5 cm	
Weight	7 kg	
Material	Solid FSC timber: Natural ash, black stained ash, natural oak Opaque polished handblown glass	
Finish	Oiled	
Technical	220–240V, UK or European plug, E27 lampholder CE Compliant, Black inline foot dimmer switch with 3 metres of black cotton braided round flex cable	
Lamp source (included)	E27 LED Dimmable, Max 11.2W/1520lm Tala Globe Bulb E27, matte white, Dim to Warm 2000-3000K	
CoO Origin	UK	
HS Code	9405299090	
Tests and Certifications	Tests: CE Compliant Certificates: FSC 100% and PEFC 100%	
Package dimensions	Base: W49.5 × D36 × H48.5 cm Shade: W40 × D40 × H43 cm	
Packaged weight	Base: 4kg Shade: 4kg	
Availability	Lead time 8–10 weeks	
Price	SKU	Excl. VAT
Black stained ash	TT-CFL-A-B	1,357 EUR
Natural ash	TT-CFL-A-N	1,425 EUR
Natural oak	TT-CFL-O-N	1,473 EUR

Retail (RRP) excluding duties, VAT, shipping fees and import taxes

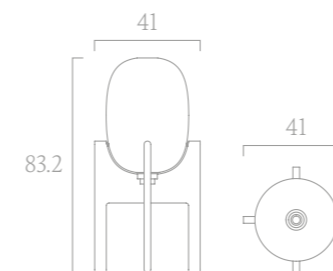

[View Clore Floor Lamp](#)

Clore Lounge Chair

The Clore Lounge Chair references the private penthouse of the late philanthropist and arts patron Sir Charles Clore, whose home Tamar de Shalit designed in 1963. The chair features a gently curved seat and back on a reclined timber frame. The (no-foam) upholstery is made with layers of 100% natural and recycled materials, onto a solid wood stretcher. The compact easy chair is perfect for both residential and public environments. The chair is complemented by the Clore Ottoman, Clore Coffee Table and Clore Floor Lamp in the Clore furniture range.

The chair is offered in a range of fixed covers in natural wool textiles, including Contrast, an exclusively produced black and white woven wool fabric (produced by Bute Fabrics) based on an original fashion textile designed by Tamar de Shalit. Customers Own Material (COM): 2 metres per chair is available subject to the fabric approval by Tamart. The cushioned seat and back can be removed for reupholstery. Fixed inserted felt feet pads are standard.

Dimensions	W74 × D73 × H74 cm Seat height: 36 cm
Weight	13.6 kg
Material	Solid FSC timber: Natural ash, black stained ash, natural oak
Finish	Oiled
Upholstery Inner	Solid timber, natural and recycled materials
Textiles	Contrast by Tamart – 100% Wool Natural wool fabric ranges *Customers Own Materials (COM)
CoO Origin	UK
HS Code	9401610000
Tests and Certifications	Tests: EN 16139:2013, BS5852, Crib 5 Certificates: FSC 100% and PEFC 100%
Package dimensions	W75 × D76 × H75 cm
Packaged weight	16 kg
Availability	Lead time 8–10 weeks

Price (black stained ash)	SKU	Excl. VAT
Fabric 0: Contrast or COM*	TT-CLC-A-B-F0	2,109 EUR
Fabric 1: Boucle	TT-CLC-A-B-F1	2,497 EUR
Price (natural ash)	SKU	Excl. VAT
Fabric 0: Contrast or COM*	TT-CLC-A-N-F0	2,271 EUR
Fabric 1: Boucle	TT-CLC-A-N-F1	2,679 EUR
Price (natural oak)	SKU	Excl. VAT
Fabric 0: Contrast or COM*	TT-CLC-O-N-F0	2,497 EUR
Fabric 1: Boucle	TT-CLC-O-N-F1	3,115 EUR
Fabric 2: Sheepskin	TT-CLC-O-N-F2	4,212 EUR

Retail (RRP) excluding duties, VAT, shipping fees and import taxes

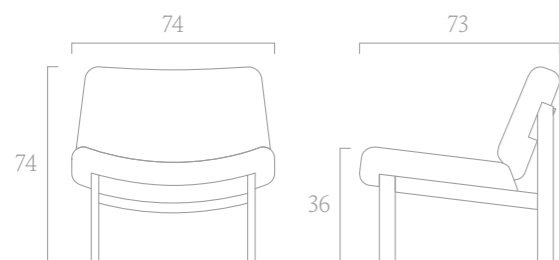

[View Clore Lounge Chair](#)

Clore Ottoman

The Clore Ottoman references the private penthouse of the late philanthropist and arts patron Sir Charles Clore, whose home Tamar de Shalit designed in 1963. The ottoman follows the same principles as the Clore Lounge Chair and can be used as a footrest or independently as a stool. The (no-foam) upholstery is made with layers of 100% natural and recycled materials, onto a solid wood stretcher. The low seating option is perfect for both residential and public environments and is part of Tamart's Clore furniture collection.

Offered in a range of fixed covers in natural wool textiles, including Contrast, an exclusively produced black and white woven wool fabric (produced by Bute Fabrics) based on an original fashion textile designed by Tamar de Shalit. Customers Own Material (COM): 1 metre per seat is available subject to the fabric approval by Tamart. The cushioned seat can be removed for reupholstery. Fixed inserted felt feet pads are standard.

Dimensions	W61 × D45 × H36 cm
Weight	5.9 kg
Material	Solid FSC timber: Natural ash, black stained ash, natural oak
Finish	Oiled
Upholstery Inner	Solid timber, natural and recycled materials
Textiles	Contrast by Tamart – 100% Wool Natural wool fabric ranges *Customers Own Materials (COM)
CoO Origin	UK
HS Code	9401610000
Tests and Certifications	Tests: EN 16139:2013, BS5852, Crib 5 Certificates: FSC 100% and PEFC 100%
Package dimensions	W62 × D47 × H38 cm
Packaged weight	6.5 kg
Availability	Lead time 8–10 weeks

Price (black stained ash)	SKU	Excl. VAT
Fabric 0: Contrast or COM*	TT-CO-A-B-F0	941 EUR
Fabric 1: Boucle	TT-CO-A-B-F1	1,021 EUR
Price (natural ash)	SKU	Excl. VAT
Fabric 0: Contrast or COM*	TT-CO-A-N-F0	1,045 EUR
Fabric 1: Boucle	TT-CO-A-N-F1	1,083 EUR
Price (natural oak)	SKU	Excl. VAT
Fabric 0: Contrast or COM*	TT-CO-O-N-F0	1,066 EUR
Fabric 1: Boucle	TT-CO-O-N-F1	1,099 EUR

Retail (RRP) excluding duties, VAT, shipping fees and import taxes

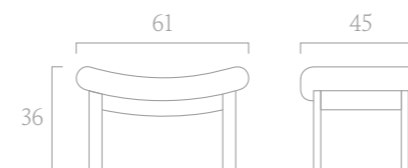

[View Clore Ottoman](#)

Clore Coffee Table

The Clore Coffee Table references the private penthouse of the late philanthropist and arts patron Sir Charles Clore, whose home Tamar de Shalit designed in 1963. The coffee table features solid wood frames that are crafted with pocket dovetail joinery details for tool-free assembly. The tabletop simply rests neatly, without fixings, (on clear protective bumpers) on top of the frame, its weight securing the design. The Clore Coffee Table is available with either extra-clear or smoked, toughened glass, stone or solid wood tops, the latter matching the premium AA graded hardwood table frames.

The timber base of the Clore Coffee Table can be purchased as a 'frame only' item, allowing the customer to locally source their own tops (reducing carbon footprint). It arrives flat packed in 4 pieces and simply slots together with the gentle aid of a G-clamp. Fixed felt feet pads are partially recessed into the legs and come as standard. Top specifications available on request. N.B. Glass tops are supplied to the UK only. *

Dimensions	Frame only: L114×D87×H45 cm Glass* top only: L130×W75×D1.2 cm Wood top only: L130×W75×D3 cm Complete table: L130×D87×H45 cm
Weight	Frame only: 7.65 kg Glass* top: 30 kg Wood top: 32 kg
Material	Solid FSC timber: Natural ash, black stained ash, natural oak Top options: glass, wood, stone
Finish	Timber: oiled Glass top: extra clear or smoked
CoO Origin	Frame: PL Tops: Wood PL, Glass UK
HS Code	9403601000
Tests and Certifications	Tests: BS EN 15372:2016 Certificates: FSC 100% and PEFC 100%
Package dimensions	Frame only: W130 × D75 × H7.8 cm Glass* top: L132×W77×D5 cm Wood top: L132×W77×D4 cm
Packaged weight	Frame only: 10 kg Glass* top: 34 kg Wood top: 32 kg
Availability	Lead time 8–10 weeks

Price: Frame only	SKU	Excl. VAT
Black stained ash	TT-CCTF-L-A-B	656 EUR
Natural ash	TT-CCTF-L-A-N	793 EUR
Natural oak	TT-CCTF-L-O-N	901 EUR
Price: Table with Glass Top	SKU	Excl. VAT
Black stained ash	TT-CCT-L-A-B-G	1,254 EUR
Natural ash	TT-CCT-L-A-N-G	1,425 EUR
Natural oak	TT-CCT-L-O-N-G	1,539 EUR
Price: Table with Wood Top	SKU	Excl. VAT
Black stained ash	TT-CCT-L-A-B-W	1,653 EUR
Natural ash	TT-CCT-L-A-N-W	1,796 EUR
Natural oak	TT-CCT-L-O-N-W	2,223 EUR

Retail (RRP) excluding duties, VAT, shipping fees and import taxes

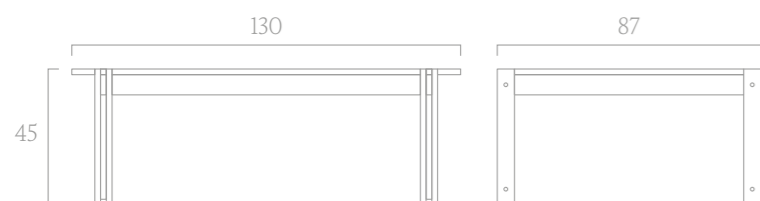

[View Clore Coffee Table](#)

Clore Dining Table

The Clore Dining Table joins the Clore Coffee Tables as part of the Clore Collection, referencing the 1960s penthouse designed by Tamar de Shalit. The new reimagined piece features solid wood framing and is available with extra-clear or smoked toughened glass and solid wooden tops matching the timber frames. The glass tabletops simply rest neatly, without fixings, (on clear protective bumpers) on top of the frame, its weight securing the design. The timber tops are secured to the base.

The frame of the Clore Dining Table can be purchased separately, allowing customers to locally source their own tops (reducing carbon footprint). It arrives flat-packed in 4 pieces and slots together in minutes with a few fixings. Fixed felt feet pads come as standard. Top specifications available on request. N.B. Glass tops are supplied to the UK only. *

Dimensions	Frame only: L145×D98×H74 cm Glass* top only: L200×W90×D1.2 cm Wood top only: L200×W90×D3 cm Complete table: L200×D98×H74 cm
Weight	Frame only: 13.6 kg Glass* top: 48 kg Wood top: 42 kg
Material	Solid FSC timber: Natural ash, black stained ash, natural oak Top options: glass, wood, stone
Finish	Timber: oiled Glass top: extra clear or smoked
CoO Origin	Frame: PL Tops: Wood PL, Glass UK
HS Code	9403601000
Certifications	Certificates: FSC 100% and PEFC 100%
Package dimensions	Frame only: W135.4×D95.6×H12.1 cm Glass* top: L200×W90×D5 cm Wood top: L200×W90×D4 cm
Packaged weight	Frame only: 15 kg Glass* top: 50 kg Wood top: 45 kg
Availability	Lead time 8–10 weeks

Price: Frame only	SKU	Excl. VAT
Black stained ash	TT-CDTF-A-B	1,021 EUR
Natural ash	TT-CDTF-A-N	1,095 EUR
Natural oak	TT-CDTF-O-N	1,254 EUR
Price: Table with Glass Top	SKU	Excl. VAT
Black stained ash	TT-CDT-A-B-G	2,223 EUR
Natural ash	TT-CDT-A-N-G	2,497 EUR
Natural oak	TT-CDT-O-N-G	2,793 EUR
Price: Table with Wood Top	SKU	Excl. VAT
Black stained ash	TT-CDT-A-B-W	2,588 EUR
Natural ash	TT-CDT-A-N-W	2,793 EUR
Natural oak	TT-CDT-O-N-W	3,306 EUR

Retail (RRP) excluding duties, VAT, shipping fees and import taxes



[View Clore Dining Table](#)

Highgate Chair

The new Highgate Chair takes its design cues from essential modernist principles with its simple rectangular construction and strict geometric appearance inspired by designs from the 1960s in Tamart's archive. The contemporary pill-shaped, comfortably angled back and bullnose curved stile tops and feet soften the appearance while the fine, naturally dyed leather sling-style seat gives the chair a lightness. The light padded leather seat, with contrast stitching is tension-fitted allowing the comfort to be adjusted and refreshed.

The perfect companion to Tamart's Clore Dining Table as a meeting or dining chair. The versatile side chair is suitable as a stand-alone seat for community meetings and ecclesiastical areas, or residential and hospitality dining. The timber frame is offered in sustainably sourced natural oak and black stained ash with a choice of matching or contrasting colours of natural vegetable-tanned leather sling seats. Fixed felt feet pads are partially recessed into the legs and come as standard.

*New: Timber and fabric seats available in 2026

Dimensions	W49×D50×H80 cm Seat height: 45 cm
Weight	4.81 kg
Material	Solid FSC timber: black stained ash, natural oak
Finish	Oiled
Seat	Natural vegetable tanned leather and natural canvas *
Colours	Chestnut, black, natural
CoO Origin	PL
HS Code	9401610000
Tests and Certifications	Tests: EN 16139:2013, BS 5852:2006, Section 12, Crib 5 Certificates: FSC 100% and PEFC 100%
Package dimensions	W63.4×D53.8×H86 cm
Packaged weight	6 kg (one chair) 11 kg (two chairs) N.B. MOQ 2, this item is ordered and shipped as 2 chairs
Availability	Lead time 8–10 weeks

Price	SKU	Excl. VAT
Black stained ash, Black	TT-HC-A-B-LB	938 EUR
Black stained ash, Natural	TT-HC-A-B-LN	938 EUR
Black stained ash, Chestnut	TT-HC-A-B-LC	938 EUR
Natural oak, Black	TT-HC-O-N-LB	1,296 EUR
Natural oak, Natural	TT-HC-O-N-LN	1,296 EUR
Natural oak, Chestnut	TT-HC-O-N-LC	1,296 EUR

Retail (RRP) excluding duties, VAT, shipping fees and import taxes

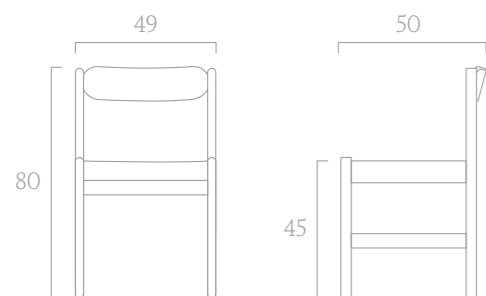

[View Highgate Chair](#)

Highgate Chair with Arms

The new Highgate Chair with Arms, the more generous companion to the Highgate Chair, takes its design cues from essential modernist principles with its simple rectangular construction and strict geometric appearance. The contemporary pill-shaped, comfortably angled back and bullnose curved stile tops and feet soften the appearance, while the fine, naturally dyed leather sling-style seat gives the chair a lightness. The light padded leather seat, with contrast stitching is tension-fitted allowing the comfort to be adjusted and refreshed.

The arm height fits perfectly under Tamart's Clore Dining Table. The versatile chair is suitable as a stand-alone seat for meeting and reception areas or residential and hospitality dining. The timber frame is offered in sustainably sourced natural oak and black stained ash with a choice of matching or contrasting colours of natural vegetable-tanned leather sling seats. Fixed felt feet pads are partially recessed into the legs and come as standard.

*New: Timber and fabric seats available in 2026

Dimensions	W58×D50×H80 cm Seat height: 45 cm Arm height: 71 cm
Weight	5.85 kg
Material	Solid FSC timber: black stained ash, natural oak
Finish	Oiled
Seat	Natural vegetable tanned leather and natural canvas *
Colours	Chestnut, black, natural
CoO Origin	PL
HS Code	9401610000
Tests and Certifications	Tests: EN 16139:2013, BS 5852:2006, Section 12, Crib 5 Certificates: FSC 100% and PEFC 100%
Package dimensions	W63.4×D53.8×H86 cm
Packaged weight	7 kg
Availability	Lead time 8–10 weeks

Price	SKU	Excl. VAT
Black stained ash, Black	TT-HCA-A-B-LB	1,125 EUR
Black stained ash, Natural	TT-HCA-A-B-LN	1,125 EUR
Black stained ash, Chestnut	TT-HCA-A-B-LC	1,125 EUR
Natural oak, Black	TT-HCA-O-N-LB	1,415 EUR
Natural oak, Natural	TT-HCA-O-N-LN	1,415 EUR
Natural oak, Chestnut	TT-HCA-O-N-LC	1,415 EUR

Retail (RRP) excluding duties, VAT, shipping fees and import taxes

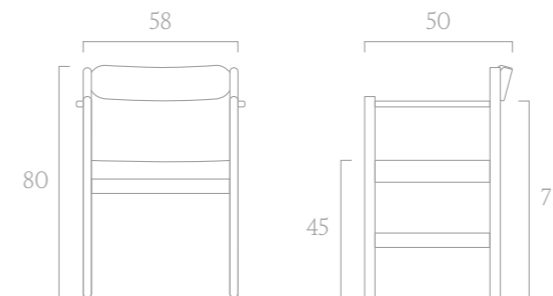

[View Highgate Chair with Arms](#)

Highgate Bar Stools

The Highgate Bar Stool is a new addition to Tamart's seating range, drawing design cues from modernist principles that define the Highgate collection. With a 80cm seat height, this elegant, sturdy piece is offered in two models: one featuring the signature pill-shaped lumbar backrest, and a spare, elemental backless design. The padded leather sling-style seat utilises 'Tamart innovation' tension-fitting, allowing comfort to be adjusted and reset as needed. An ideal companion to any hotel bar or workplace environment. Fixed felt feet pads are partially recessed into the legs and come as standard.

*New: Timber and fabric seats available in 2026

Dimensions	Seat height: 80 cm With backrest: W46×D46×H98 cm Without backrest W46×D44×H80 cm
Weight	With backrest: 9.6kg Without backrest: 8kg
Material	Solid FSC timber: black stained ash, natural oak
Finish	Oiled
Seat	Natural vegetable tanned leather and natural canvas *
Colours	Chestnut, black, natural
CoO Origin	PL
HS Code	9401610000
Certifications	Certificates: FSC 100% and PEFC 100%
Package dimensions	With backrest: W50×D50×H100 cm Without backrest: W50×D50×H84 cm
Packaged weight	With backrest: 10kg Without backrest: 8.5 kg
Availability	Lead time 8–10 weeks

Frame Seat		
Price, with backrest	SKU	Excl. VAT
Black stained ash, Black	TT-HBS-B-A-B-LB	938 EUR
Black stained ash, Natural	TT-HBS-B-A-B-LN	938 EUR
Black stained ash, Chestnut	TT-HBS-B-A-B-LC	938 EUR
Natural oak, Black	TT-HBS-B-O-N-LB	1,296 EUR
Natural oak, Natural	TT-HBS-B-O-N-LN	1,296 EUR
Natural oak, Chestnut	TT-HBS-B-O-N-LC	1,296 EUR
Price, no backrest	SKU	Excl. VAT
Black stained ash, Black	TT-HBS-A-B-LB	901 EUR
Black stained ash, Natural	TT-HBS-A-B-LN	901 EUR
Black stained ash, Chestnut	TT-HBS-A-B-LC	901 EUR
Natural oak, Black	TT-HBS-O-N-LB	1,129 EUR
Natural oak, Natural	TT-HBS-O-N-LN	1,129 EUR
Natural oak, Chestnut	TT-HBS-O-N-LC	1,129 EUR

Retail (RRP) excluding duties, VAT, shipping fees and import taxes

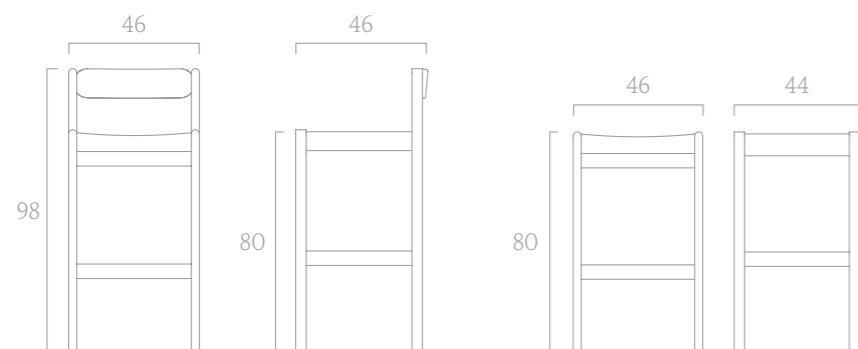

[View Highgate Bar Stools](#)

Highgate Counter Stools

Complementing the Highgate collection, the Counter Stool brings refined modernist design to counter-height spaces. With a 65 cm seat height, this versatile piece mirrors the principles of its taller counterpart. Available in two models – with the characteristic pill-shaped lumbar support or in a clean, backless configuration – each features the signature padded leather sling seat with 'Tamart innovation' tension-fitting for adjustable comfort. Perfect for kitchen islands, counter dining and workplace environments. Fixed felt feet pads are partially recessed into the legs and come as standard.

*New: Timber and fabric seats available in 2026

Dimensions	Seat height: 65 cm With backrest: W46×D46×H88 cm Without backrest: W46×D44×H65 cm
Weight	With backrest: 8.6kg Without backrest: 7kg
Material	Solid FSC timber: black stained ash, natural oak
Finish	Oiled
Seat	Natural vegetable tanned leather and natural canvas *
Colours	Chestnut, black, natural
CoO Origin	PL
HS Code	9401610000
Certifications	Certificates: FSC 100% and PEFC 100%
Package dimensions	With backrest: W50×D50×H90 cm Without backrest: W50×D50×H66 cm
Packaged weight	With backrest: 9kg Without backrest: 7.4 kg
Availability	Lead time 8–10 weeks

Frame Seat		
Price, with backrest	SKU	Excl. VAT
Black stained ash, Black	TT-HCS-B-A-B-LB	938 EUR
Black stained ash, Natural	TT-HCS-B-A-B-LN	938 EUR
Black stained ash, Chestnut	TT-HCS-B-A-B-LC	938 EUR
Natural oak, Black	TT-HCS-B-O-N-LB	1,296 EUR
Natural oak, Natural	TT-HCS-B-O-N-LN	1,296 EUR
Natural oak, Chestnut	TT-HCS-B-O-N-LC	1,296 EUR
Price, no backrest	SKU	Excl. VAT
Black stained ash, Black	TT-HCS-A-B-LB	901 EUR
Black stained ash, Natural	TT-HCS-A-B-LN	901 EUR
Black stained ash, Chestnut	TT-HCS-A-B-LC	901 EUR
Natural oak, Black	TT-HCS-O-N-LB	1,129 EUR
Natural oak, Natural	TT-HCS-O-N-LN	1,129 EUR
Natural oak, Chestnut	TT-HCS-O-N-LC	1,129 EUR

Retail (RRP) excluding duties, VAT, shipping fees and import taxes

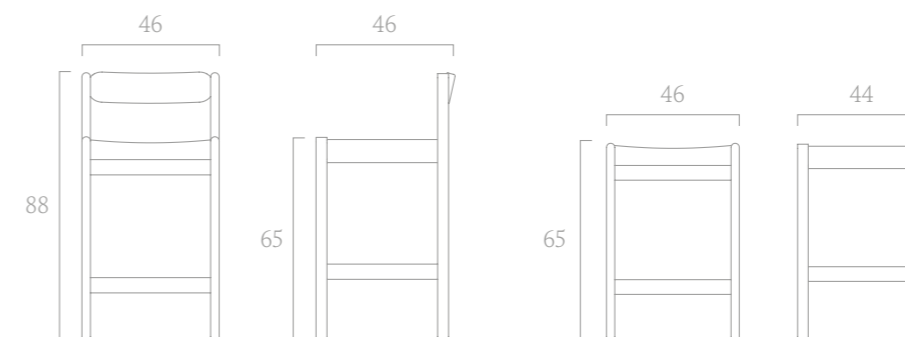

[View Highgate Counter Stools](#)

Red Rock Club Chair

The Red Rock Club Chair originates from a furniture series custom-created for the famous 1970s Red Rock Hotel and Club, designed by Arthur Goldreich and Tamar de Shalit. The chair offers a compact footprint and low seating, giving it a naive and playful feel. Its stiles are topped with tactile carved spheres, inviting people to hold on while standing behind. The chair features solidly proportioned legs which taper at the feet and feel pleasingly substantial.

Offered in a range of fixed covers in fabric or leather, including Contrast, an exclusive Tamart monochrome woven wool fabric (produced by Bute Fabrics) based on an original 1980s textile designed by Tamar de Shalit. Customers own materials (COM) are subject to approval by Tamart. The cushioned seat and back can be removed for reupholstery. Fixed felt foot pads are partially recessed into the legs and come as standard.

Dimensions	W48×D45×H84 cm Seat height 34 cm
Weight	8.9 kg
Material	Solid FSC timber Natural ash, black stained ash, natural oak
Finish	Oiled
Textiles	Contrast by Tamart – 100% Wool Natural wool fabric and leather ranges *Customers Own Materials (COM)
CoO Origin	United Kingdom
Tests and Certifications	Tests: BS5852, Crib 5 Certificates: FSC 100% and PEFC 100%
Availability	Lead time 8–10 weeks

Price (black stained ash)	SKU	Excl. VAT
Fabric 0: Contrastor COM*	TT-RRCC-A-B-F0	1,254 EUR
Fabric 1: Boucle	TT-RRCC-A-B-F1	1,368 EUR
Leather	TT-RRCC-A-B-L	1,482 EUR
Price (natural ash)	SKU	Excl. VAT
Fabric 0: Contrast or COM*	TT-RRCC-A-N-F0	1,368 EUR
Fabric 1: Boucle	TT-RRCC-A-N-F1	1,539 EUR
Leather	TT-RRCC-A-N-L	1,653 EUR
Price (natural oak)	SKU	Excl. VAT
Fabric 0: Contrast or COM*	TT-RRCC-O-N-F0	1,539 EUR
Fabric 1: Boucle	TT-RRCC-O-N-F1	1,699 EUR
Leather	TT-RRCC-O-N-L	1,802 EUR

Retail (RRP) excluding duties, VAT, shipping fees and import taxes

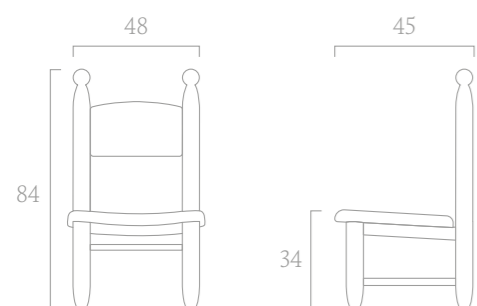

[View Red Rock Club Chair](#)

Red Rock Club Stool

The Red Rock Club Stool, which also works as a side table, originates from a furniture series custom-created for the famous 1970s Red Rock Hotel and Club, designed by Arthur Goldreich and Tamar de Shalit. This piece follows the same principles as the Red Rock Club Chair with its solidly proportioned legs which taper at the feet. The stool is crafted from Tamart's sustainably sourced timbers – natural oak, ash and black stained ash, with an oiled finish. The furniture arrives assembled as one piece. Fixed inserted felt foot pads are standard. Fixed felt foot pads are partially recessed into the legs and come as standard.

Dimensions	Ø 35 cm × H35 cm
Weight	4.1 kg
Material	Solid FSC timber Natural ash, black stained ash, natural oak
Finish	Oiled
CoO Origin	PL
Certifications	Certificates: FSC 100% and PEFC 100%
Availability	Lead time 8–10 weeks

Price	SKU	Excl. VAT
Black stained ash	TT-RRCS-A-B	399 EUR
Natural ash	TT-RRCS-A-N	439 EUR
Natural oak	TT-RRCS-O-N	479 EUR

Retail (RRP) excluding duties, VAT, shipping fees and import taxes



[View Red Rock Club Stool](#)

Red Rock Club Lounge Table

The Red Rock Club Lounge Table originates from a furniture series custom-created for the famous 1970s Red Rock Hotel and Club, designed by Arthur Goldreich and Tamar de Shalit. This piece follows the same principles as the Red Rock Club Chair and Stool with the distinctive broad turned legs and curved tapered feet; the table has a compact footprint and has a table height of 60 cm. The stool is crafted from European sustainably sourced timbers – natural oak, ash and black stained ash – with an oiled finish. Fixed inserted felt feet pads are standard. Its refined construction means that the legs simply screw on, making it easy to transport. Fixed felt feet pads are partially recessed into the legs and come as standard.

Dimensions	L100×D45×H60 cm
Weight	16.4 kg
Material	Solid FSC timber Natural ash, natural oak, black stained ash
Finish	Oiled
CoO Origin	EU
Certifications	Certificates: FSC 100% and PEFC 100%
Availability	Lead time 8–10 weeks

Price	SKU	Excl. VAT
Black stained ash	TT-RRCLT-A-B	662 EUR
Natural ash	TT-RRCLT-A-N	710 EUR
Natural oak	TT-RRCLT-O-N	850 EUR

Retail (RRP) excluding duties, VAT, shipping fees and import taxes

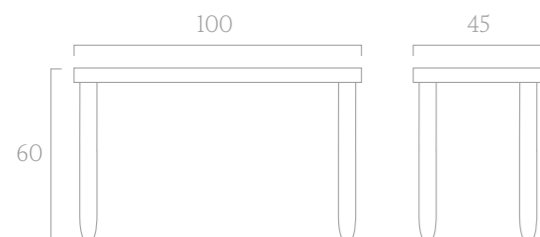

[View Red Rock Club Lounge Table](#)

Colours and Materials

All Tamart products are made in the UK and Europe. Tamart takes great care to use the finest quality or recycled materials and employs sustainable production techniques to enhance the lifespan of each piece of furniture. All Tamart products are repairable and recyclable. Read our sustainability statement [here](#).

Wood

All Tamart wooden products are crafted by producers that use European FSC timbers, and an oiled (plant-based) finish, and are available in black-stained ash, or natural ash and oak. With 40% less waste, the black stained ash is the most sustainable timber.

Glass | Clore Tables

12mm Toughened, extra clear PAR. Glass tops are only supplied in the UK, please contact us for outside UK deliveries.

Glass | Clore Lamp Shade

Handblown opaque glass crafted in Czechia by artisans using metals moulds and by layering opaque white and clear polished glass.

Leather

The natural vegetable-tanned leathers are sourced in Europe and are available in black, natural or chestnut colours.

Upholstery

Layers of recycled and natural pure fibres are built by hand over solid timber frames and stretchers.

Textiles

Each upholstered piece is offered in a range of natural wool textiles from the British textile producers Mournie Textiles (fabric 02 Mist, Pebble, fabric 03 Cloughmore) and Bute Fabrics (fabric 01 Teddy), as well as an exclusive Tamart-designed fabric called Contrast. Customers Own Materials (COM) is also offered.

Contrast

A 100% pure new wool tweed, is exclusively produced for Tamart's debut product collection. Tamart has worked closely with Bute Fabrics to develop the Bute Tweed range, to create Contrast – a bespoke black and white woven fabric based on an original fashion textile designed by Tamar de Shalit.

Contrast by Tamart

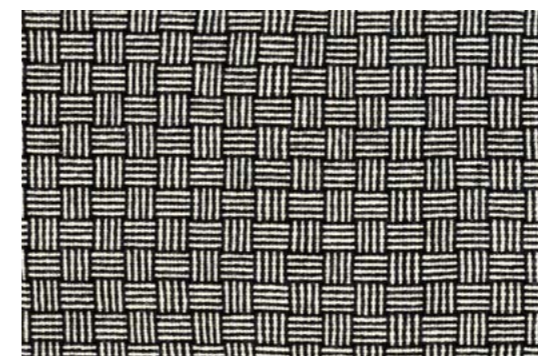

100% Pure new wool tweed

Wood



Black Stained Ash



Natural Ash



Natural Oak

Tops



Stone



Glass



Smoked Glass

Leather



Black



Natural



Chestnut

Fabrics



Contrast



01











































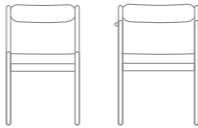







02

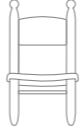

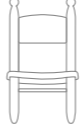
03

Materials Chart

	Wood	Top	Leather	Fabric
Central Stool	 			
				
Clore Floor Lamp	 			
				
Clore Lounge Chair	 			 
				 
Clore Ottoman	 			 
				 
Clore Coffee Table	 	 		
	 			

	Wood	Top	Leather	Fabric
Clore Dining Table	 	 		
	 			
Highgate Chairs	 		 	
			 	
Highgate High Stools	 		 	
			 	
Red Rock Club Chair	 		 	 
			 	 
Red Rock Lounge Stool Table	 			
				

Collection

	Material	EUR Excl. VAT
Central Stool (single)	Black stained ash	371
	Natural ash	439
	Natural oak	474
Central Stool (pair)	Black stained ash	661
	Natural ash	751
	Natural oak	836
Clore Floor Lamp	Black stained ash	1,357
	Natural ash	1,425
	Natural oak	1,473
Clore Lounge Chair	Black stained ash (Fabric 0)	2,109
	Black stained ash (Fabric 1)	2,497
	Natural ash (Fabric 0)	2,271
	Natural ash (Fabric 1)	2,679
	Natural oak (Fabric 0)	2,497
	Natural oak (Fabric 1)	3,115
	Natural oak (Fabric 2)	4,212
Clore Ottoman	Black stained ash (Fabric 0)	941
	Black stained ash (Fabric 1)	1,021
	Natural ash (Fabric 0)	1,045
	Natural ash (Fabric 1)	1,083
	Natural oak (Fabric 0)	1,066
	Natural oak (Fabric 1)	1,099
Clore Coffee Table (frame only)	Black stained ash	656
	Natural ash	793
	Natural oak	901
Clore Coffee Table (with glass top)	Black stained ash	1,254
	Natural ash	1,425
	Natural oak	1,539
Clore Coffee Table (with wood top)	Black stained ash	1,653
	Natural ash	1,796
	Natural oak	2,223
Clore Dining Table (frame only)	Black stained ash	1,021
	Natural ash	1,095
	Natural oak	1,254
Clore Dining Table (with glass top)	Black stained ash	2,223
	Natural ash	2,497
	Natural oak	2,793
Clore Dining Table (with wood top)	Black stained ash	2,588
	Natural ash	2,793
	Natural oak	3,306

	Material	EUR Excl. VAT
Highgate Chair	Black stained ash	938
	Natural oak	1,296
Highgate Chair with Arms	Black stained ash	1,125
	Natural oak	1,415
Highgate Bar Stool (with backrest)	Black stained ash	938
	Natural oak	1,296
Highgate Bar Stool (without backrest)	Black stained ash	901
	Natural oak	1,129
Highgate Counter Stool (with backrest)	Black stained ash	938
	Natural oak	1,296
Highgate Counter Stool (without backrest)	Black stained ash	901
	Natural oak	1,129
Red Rock Club Chair	Black stained ash (Fabric 0)	1,254
	Black stained ash (Fabric 1)	1,368
	Black stained ash (Leather)	1,482
	Natural ash (Fabric 0)	1,368
	Natural ash (Fabric 1)	1,539
	Natural ash (Leather)	1,653
	Natural oak (Fabric 0)	1,539
	Natural oak (Fabric 1)	1,699
Natural oak (Leather)	1,802	
Red Rock Club Stool	Black stained ash	399
	Natural ash	439
	Natural oak	479
Red Rock Lounge Table	Black stained ash	662
	Natural ash	710
	Natural oak	850

Contacts

Tamart
The Wax Building
4 Garden Walk
London EC2A 3EQ
United Kingdom

tamartdesign.com

+44(0)20 7870 8201
sales@tamartdesign.com
Instagram @tamart.designs
LinkedIn @tamartdesigns

Trade Pack Downloads
CAD and 3D files
Download catalogue
Our Sustainability Statement

Tamart Design Limited
EU VAT Registration Number: PL5263860062.
Company Number Registered in England: no. 14628487
UK VAT Registration Number: GB454722390
EORI Number: GB454722390000

Notes. Prices shown are List and Retail (RRP)
excluding and including VAT,
they also exclude shipping, duties or
other import/tax fees. Tamart reserves
the right to carry out price and
description modifications of products
when necessary and without prior notice.
For full Terms and Conditions email
sales@tamartdesign.com

01.05.2026

© 2026 Tamart Design Limited